

ecotech ®

VARIABLE SPEED POOL PUMP MOTOR & CONTROL

· INNOVATION *MADE*  ·

INSTALLATION AND MAINTENANCE MANUAL

For Non-SVRS Models

Programmable Pool Pump Motor/Control

⚠ WARNING This Product Does **NOT** Provide
A Safety Vacuum Release System (SVRS).

Save this instruction manual for future reference.



M017898010000 REV: August 31, 2012

IMPORTANT SAFETY INSTRUCTIONS

ECOTECH EZ® Motor/Control Installation & Maintenance Manual

Save this Instruction Manual for future reference.

Table of Contents

| | |
|---|-------|
| About the ECOTECH EZ® Motor/Control | 3 |
| Important Safety Information | 4–6 |
| General Installation Information. | 6 |
| Basic Motor/Control Operation | 7–8 |
| User Interface | 9–11 |
| Programming Flow Chart. | 12 |
| How to program your ECOTECH EZ® Motor/Control. | 13–17 |
| Programming Pump Priming | 18 |
| Starting & Stopping the unit. | 20 |
| Run the unit per the Program Schedule | 20 |
| Prime the Pump. | 20 |
| Run Hi Speed / Vacuum | 21 |
| Run Custom Flow | 21 |
| Locking the Keypad. | 22–23 |
| Run the unit with other equipment pad items | 23 |
| Fault Conditions. | 24 |
| General Troubleshooting | 25 |
| How to Lower Utility Costs with the ECOTECH EZ® Variable Speed Motor/Control | 25 |
| Recommended Maintenance. | 26 |

For Technical Assistance or Questions related to your ECOTECH EZ® Motor/Control:

Call our Pool Motor Product Services Hotline:

1-800-566-1418

**Or email questions to:
motorhelp@nidec-motor.com**

**Or visit our web site at:
www.nidec-motor.com/pool**

About the ECOTECH EZ® Motor/Control

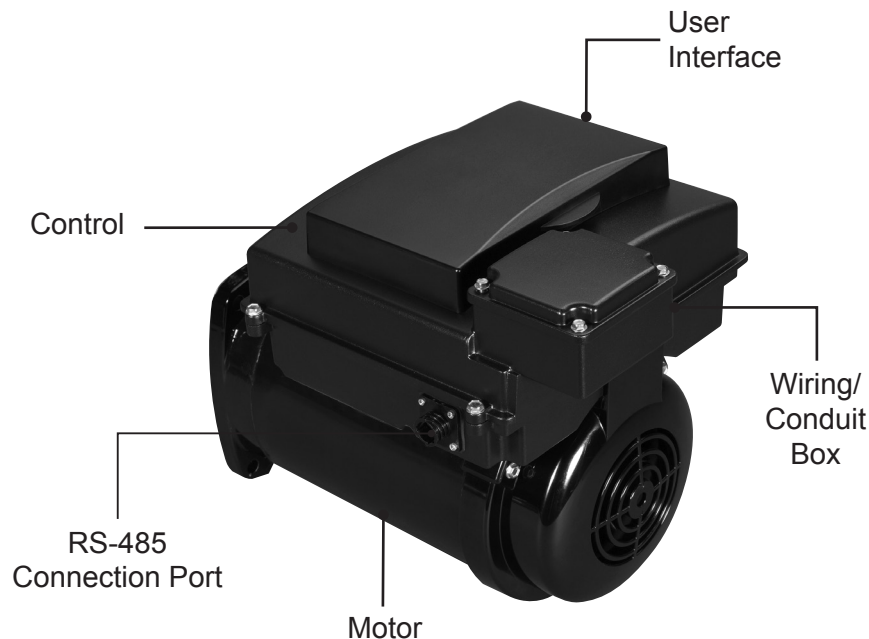

Catalog or Stock Numbers:

Catalog numbers EVSJ3-NS & EVSJ15-NS for 56J mounting & Catalog numbers EVSS3-NS & EVSS15-NS for Square Flange mounting (as pictured above)

About the ECOTECH EZ® Motor/Control

The ECOTECH EZ® motor/control is a high efficiency pool pump motor designed to be an easy drop-in replacement for your existing pool pump motor. There is no need for system control changes and this motor/control is designed to be wired with minimal modifications.

Designed with exclusive energy savings technologies, ECOTECH EZ® motor/control can be easily programmed to save significant utility dollars! The brushless permanent magnet motor, the control, and the user interface all work together providing the efficiency and ease-of-use benefits of an electronically controlled motor.

- High Efficiency – 90% Plus Motor Efficiency
- Speeds in 5% increments from 30% of Minimum Flow to 100% of Maximum Flow
- Easy Drop-in Installation – No complex wiring
- Setup the motor/control to clean your pool with the press of one button
- Ability to program up to four “Custom Flows” for your pool’s specific needs; i.e., operating water features

Features

- Brushless Permanent Magnet Motor
- Long-lasting Totally Enclosed Fan Cooled (TEFC) motor construction
- Built-In programmable user interface with a timer
- Potted, Environmentally Protected, Controller
- Meets California Title 20 legislation and other similar legislation required in other states
- High efficiency levels across the speed range
- Freeze sensor
- Designed for quiet operation
- One size fits most pump ratings
- Protection against corrosive environment
- Power Factor Corrected Input

Important Safety Instructions



Read and follow all instructions in the owner's manual and on the equipment. Failure to follow instructions could cause severe injury and/or death.



High voltage and rotating parts could cause serious or fatal injury. Safe installation, operation

and maintenance must be performed by qualified personnel. Familiarization with and adherence to the National Electric Code, NFPA (National Fire Protection Association) standards and local codes is required. It is important to observe safety precautions to protect personnel from possible injury. Personnel should be instructed for handling each of the following:



The motor shall only be used with the supplied control.



The ECOTECH EZ[®] motor/control user interface is intended for swimming pool pump applications only.



When unpacking the unit, verify all motor, control, and user interface components are not damaged. Make sure there are no visible loose wires in the wiring/conduit box. Be careful lifting the motor/control from the box. Act with care and in accordance with prescribed procedures in handling and lifting this equipment. Inspect all components for damage. Should there be damaged components, please return the product to your place of purchase.



There is a small time delay before the unit starts.



The ECOTECH EZ[®] Motor/Control is controlled for an automatic start. Starting is controlled by your program schedule or via user input through the user interface mounted on top of the motor.



In the case of a motor/control trip condition, the motor/control may restart without warning. See the Fault Condition section for details, Pages 24.



Avoid contact with energized circuits or rotating parts.



Always disconnect electrical power at the fuse box or circuit breaker before handling electrical connections. Double check to be sure Power is OFF, and that it cannot be turned on while you are working on the equipment.



Make sure the unit is electrically grounded and proper electrical installation wiring and controls are used consistent with local and national electric codes. Refer to "National Electrical Code Handbook" & NFPA No. 70. Employ qualified electricians. Insulate all connections carefully to prevent grounding or short circuits. Reinstall all conduit and terminal box covers.



To connect power to the motor/control unit, refer to the connection diagram on the nameplate. AC line power is connected via the motor/control conduit box terminal board only.



Insulate all connections carefully to prevent grounding or short circuits. Reinstall all conduit and terminal box covers! Do not force connections into the conduit



A poor electrical connection can overheat and cause terminal and/or terminal board failures. Because of this possibility, wiring harness quick-connect terminals should be regularly examined carefully for any signs of physical deterioration or loose fit to the terminals on the motor/control terminal board. If there is evidence of loose fit or deterioration, quick-connect terminals should be removed from the wiring harness and the harness wires then connected directly to the motor/control terminal board wiring terminals. Care shall be taken to ensure connections are made to the proper terminals and that adequate electrical clearances are maintained.

CAUTION Voltage to the motor/control shall be within plus or minus 10% of the nameplate voltage to avoid overheating and loss of performance.

- a. All aspects of the installation shall conform to the applicable requirements of the NEC (National Electrical Code), including Article 430 (Motor Circuits and Controllers), as well as all local codes.
- b. This motor/control should be powered from a separate circuit of adequate capacity to maintain sufficient voltage during starting and running conditions. Wire size shall be adequate to minimize voltage drop during starting and running. A qualified or licensed electrician should be used to properly size the motor/control supply circuit. Reference articles 310 and 400 of the NEC for further information on wire sizing. A #8 AWG or larger conductor must be wired to the motor/control ground/bonding lug. Use #6 AWG in Canada. Wiring, including flexible cords, should be as short as possible to minimize voltage drop. All electrical connections in this system must be secure to prevent voltage drop and localized heating. If AC power is supplied by a GFCI circuit breaker, use a dedicated circuit that has no other electrical loads. GFCI use shall be in accordance with NEC and all other applicable state, local and National electrical codes.
- c. Permanent connection of "Hot" supply wires (power wires that supply voltage) should be from a 2-pole device (Circuit breaker, relay, timer, etc.) that open-circuits all hot supply wires when the motor control is "OFF". Failure to use a 2-pole device will result in voltage being present at the motor/control and potential shock hazard.
- d. All electrical connections should be made and maintained by a qualified or licensed electrician.

WARNING Although the ECOTECH EZ® motor/control is a totally enclosed product, rare circumstances, such as but not limited to; i.e., motor submersion due to flood or high pressure water stream aimed directly at motor, might allow water to infiltrate the motor/control. If this occurs, the unit shall be serviced by a qualified service person before operating or applying power. Wet internal components may cause a shock hazard

CAUTION To avoid accidents, make sure equipment is properly protected to prevent access by children or other unauthorized personnel.

CAUTION Make sure there are no unusual noises or vibrations when the motor/control is running. If noise and vibration are apparent, see the General Troubleshooting issues on page 26.

WARNING Direct-coupled installations, (such as pool pump products), require a careful check of shaft and coupling alignment. Position the motor/control for proper alignment. Do not depend on a flexible coupling to compensate for misalignment. Do not strike the motor shaft with a hammer or other tool as this may damage the bearings.

WARNING Provide proper safeguards for personnel against rotating parts.

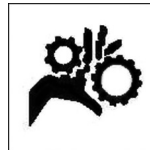

WARNING Become familiar with the equipment and read all instructions thoroughly before installing or working on the equipment.

WARNING The control on top of the motor should NEVER be disassembled for any reason.

CAUTION The User Interface should NEVER be disassembled from the control for any reason.

NOTICE The ECOTECH EZ® Motor/Control is properly packaged for shipment and storage in a clean, dry indoor area.

WARNING Safety glasses should be worn to inspect the equipment while it is running or while a mallet or hammer is used, especially if cover plates are removed.

WARNING This motor/control is not a substitute for properly installed and secured drain covers. An ANSI/ASME (American National Standards Institute/American Society of Mechanical Engineers) A112.19.8-2007 approved anti-entrapment drain cover shall be used for each drain. Pools and spas should use two drains per pump. If a drain cover becomes loose, broken or is missing, close the pool or spa immediately and shut off the pump until an approved anti-entrapment drain cover is properly installed with the manufacturer's supplied screws.

⚠ WARNING This product does **NOT** provide nor function as a safety vacuum release system (SVRS). If a SVRS is required, a product certified as a SVRS must be used.

⚠ WARNING The Association of Pool and Spa Professionals (APSP) recommends the following to keep your Pool, Spa, or Hot Tub Safe and Free from Entrapment Risk:



- a. Have your pool inspected by a licensed industry professional during initial installation.
- b. There is no backup for a broken, missing or inadequate cover. Replace any broken, missing or non-compliant covers with covers marked: VGB2008, "ASME/ANSI A112.19.8-2007," or covers showing the swimmer logo.
- c. Pools or spas with a single main drain require additional protection. Options include:
 - Eliminating the drain or reversing the flow
 - Adding a second, properly spaced outlet
 - Installing an SVRS (Safety Vacuum Release System)
 - Installing an automatic pump shut-off system
 - Installing a suction-limiting vent system
 - Adding a gravity drainage system
- d. Please check with your individual municipality to ensure proper compliance.

For additional information regarding the Virginia Graeme Baker (VGB) Pool and Spa Safety Act, consult the following web sites:

www.apsp.org
www.poolsafely.gov

⚠ WARNING This unit should not be serviced in the field. Do not disassemble or reconnect components in the field; use authorized factory service only.

⚠ WARNING Always disconnect power to the motor and **ALWAYS** disconnect any RS-485 communication cable before servicing.

⚠ WARNING Be careful when touching the exterior of an operating motor/control! The motor/control may be hot to the touch and cause injury. This condition is normal for most motors when operated at rated load and voltage. *A properly functioning motor may be too hot to touch and can cause injury.*

General Installation Instructions

Follow these instructions to prolong the life of your swimming pool pump motor/control.

- a. **Install this product on a secure and level platform or base such as a concrete pad.**
- b. Protect against heat
 - Shade the motor/control from the sun.
 - Provide ample cross ventilation to Provide sufficient cross ventilation
 - Protect the motor/control from lint, etc., that can clog the ventilation openings.
- c. Protect against Dirt
 - Keep motor/control and surrounding area clean.
 - Avoid sweeping or stirring dust near the motor/control while it is running.
 - Avoid storing or spilling dry chemicals near the motor/control.
- d. Protect against Moisture
 - Provide protection from rain, snow, etc.
 - Do not wrap motor/control with plastic or other air tight materials.
 - Locate motor/control on a slight elevation so water will not run or puddle nearby.
 - Avoid splashing water on or near the motor/control.
 - Repair leaky pipe joints or pump seals promptly.

Basic Motor/Control Operation

Your ECOTECH EZ® Motor/Control has been functionally tested for pool pump use before shipment. It is also preprogrammed to be a drop-in replacement for a standard single or two-speed pool pump motor with only minor programming required. To operate the motor/control, the installer must first set the time of day and the day of the week. Please see related informations of this manual for more specific information.

Re-inspect the installation and make sure that guards and other protective devices are securely in place. All covers and gaskets must be re-installed prior to startup to minimize the entry of dirt and moisture.

Blocked pump indicates there is an obstruction. Basic startup instructions are under the lid of the user interface. Detailed motor/control startup instructions begin on page 9 of this manual. In addition to these motor installation procedures, please follow all Startup & Operation instructions in your pump manual.



The motor/control is designed to be operated on a 230 volt, 60 Hz nominal power supply. The suitable voltage range is 207-253 volts under rated load conditions.

“Hot” power connections should only be connected to the L1 and L2 terminals of the above pictured motor/control conduit box connection area and supply ground (Green or Green with Yellow insulated lead wire) to the ground screw provided in this same connection area. Permanent field wiring should be from a 2-pole device. See Important Safety Instructions Section, Items a through d (page 5)

If AC power is supplied by a GFCI circuit breaker, use a properly sized dedicated circuit that has no other electrical loads. Use of a GFCI circuit with electrical loads other than the ECOTECH EZ® motor/control could result in nuisance tripping. See Important Safety Instructions Section for more information.

Before performing any maintenance, disconnect the power and allow the motor to come to a complete stop then wait five(5) minutes before servicing.

This motor has permanently lubricated bearings.

No further lubrication is recommended or required.

IMPORTANT NOTE: “FLOW” VS. “SPEED”

The motor/control is designed to operate at variable speed over a range of 1035 to 3450 RPM (revolutions per minute of the motor shaft). To make the product more understandable to use in pool pump applications, “FLOW” (versus “SPEED” in RPM) terminology is used to represent changes in pump water output in both the user manual instructions and on the user interface display. A motor operational speed of 1035 RPM displays as “30% FLOW”, 1725 RPM displays as “50% FLOW”, and 3450 RPM displays as “100% FLOW”. The Actual “% FLOW” rates will vary with the length of piping sections, use of fittings (elbows, tees, etc.), filters, heaters, and other components that affect system friction and efficiency, therefore, the “% FLOW” reading should only be used as an estimate of the actual system operating flow rate. When designing or calculating water turnover/exchange, the use of a properly calibrated and sized flow gauge should be used to determine actual operating flow rate (GPM) at the various operational speeds of the motor/control.

General Warnings

1. Do not open the control enclosure. There is extremely hazardous voltage inside. Do not service.



2. Code requirements vary from state to state. Install equipment in accordance with the applicable codes, local ordinances, and in accordance with the National Electrical Code.
3. Always shut off the unit before performing maintenance. Always disconnect electrical power at the fuse box or circuit breaker before handling electrical connections to be sure Power is OFF, and that it cannot be turned on while you are working on the equipment.

NOTE: The ECOTECH EZ[®] Motor/Control is programmed for an automatic start. Starting is controlled by your program schedule or via user input through the user interface mounted on top of the motor.

NOTE: There is a small time delay before the unit starts.

4. Pump size and pump impeller size must match the existing hydraulic system of the pool. The ECOTECH EZ[®] motor/control has the capability to power pump ratings up to 3.5 total or service factor horsepower (SFHP/THP) at 3450 RPM (100% Max Flow) for catalog numbers EVSJ3-NS & EVSS3-NS and pump ratings up to 2.4 total or service factor horsepower (SFHP/THP) at 3450 RPM (100% Max Flow) for catalog numbers EVSJ15-NS & EVSS15-NS.
5. This motor/control is intended to be used only above ground. It is not a submersible pump motor/control.

ECOTECH EZ® Motor/Control User Interface Operation

The User Interface (UI) is your communication means for controlling the operation of your pump. This section describes the ECOTECH EZ® Motor/Control operator controls and the LCD screen.

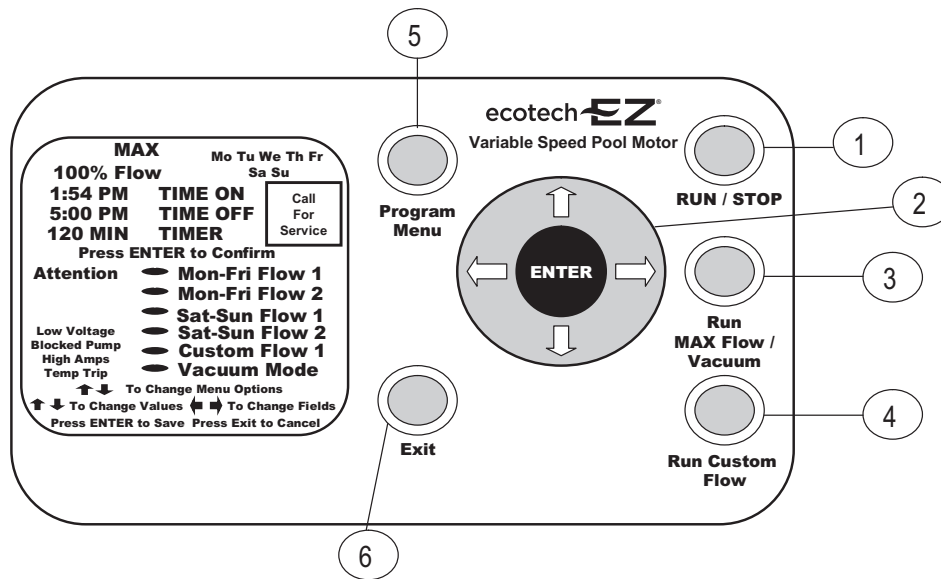

- 1 **RUN/STOP** button. This button is used to activate or stop the unit operation. The button will illuminate when in Run mode. This button does not disconnect power to the unit.
- 2 Press the **ENTER** button to confirm and save your selections. Use the arrow keys for menu navigation purposes and to change values. When the product is in the RUN mode, pressing the Up arrow increases the pump flow in 5% increments. Pressing the down arrow decreases the flow in 5% increments.
- 3 Press the **Run MAX Flow/Vacuum** button for cleaning, vacuuming, & extra skimming purposes.
- 4 Press the **Run Custom Flow** button for running water features or other special flow requirements. Custom flow rates are set in the Program Menu.
- 5 Press the **Program Menu** button to enter the Program Menu for setting time, day of week and for setting or reviewing the current Program Schedule for Pump On and Off times along with flow rates. Custom Flow settings are also set in the Program Menu.
- 6 Press the **Exit** button to leave the Program Menu or to Escape the Program Menu without saving your data.

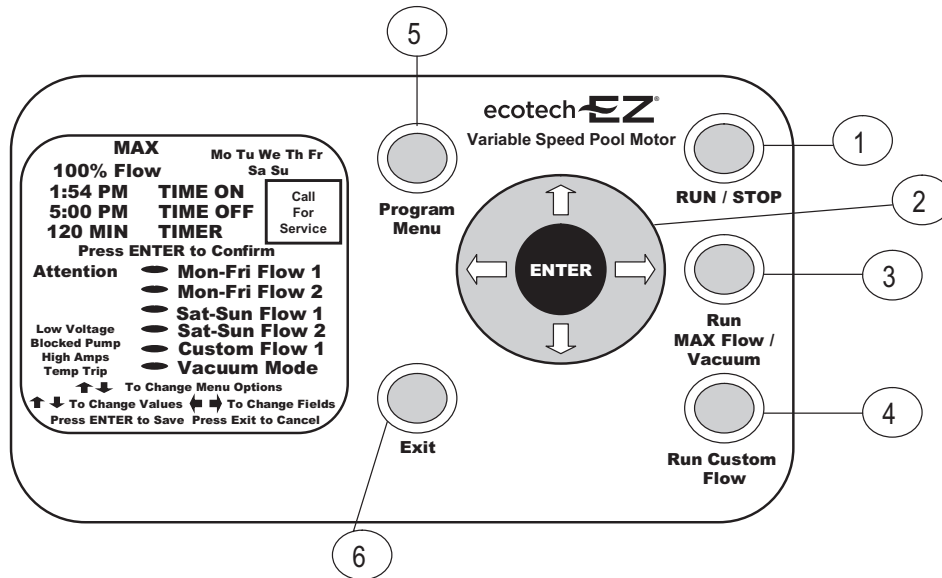

- 1 **RUN/STOP** button. This button is used to activate or stop the unit operation. The button will illuminate when in Run mode. This button does not disconnect power to the unit.
- 2 Press the **ENTER** button to confirm and save your selections. Use the arrow keys for menu navigation purposes and to change values. When the product is in the RUN mode, pressing the Up arrow increases the pump flow in 5% increments. Pressing the down arrow decreases the flow in 5% increments.
- 3 Press the **Run MAX Flow/Vacuum** button for cleaning, vacuuming, & extra skimming purposes.
- 4 Press the **Run Custom Flow** button for running water features or other special flow requirements. Custom flow rates are set in the Program Menu.
- 5 Press the **Program Menu** button to enter the Program Menu for setting time, day of week and for setting or reviewing the current Program Schedule for Pump On and Off times along with flow rates. Custom Flow settings are also set in the Program Menu.
- 6 Press the **Exit** button to leave the Program Menu or to Escape the Program Menu without saving your data.

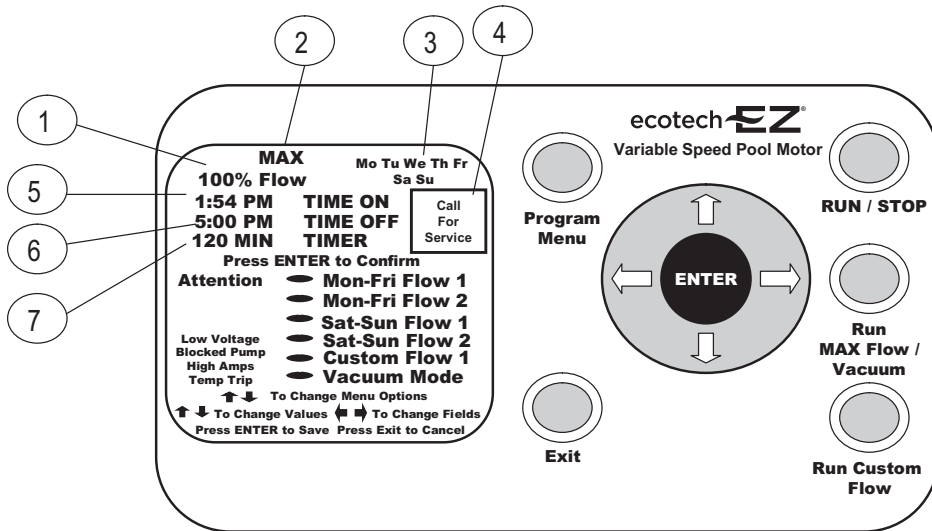

- 1 This is the current flow or speed of the motor which powers the pump. The flow range is between 30% and 100% in 5% increments.
- 2 The word "MAX" appears only when the motor speed is running at Maximum Speed or 100% of Flow. The MAX flashes when in Prime mode.
- 3 Day of the week display.
- 4 The Call for Service icon will light when an issue with the unit requires professional service. If this icon illuminates, please call your professional service representative.
- 5 The current Time of Day when in Run Mode or your Scheduled Time ON setting when in Program mode.
- 6 When in Program mode, this is the time the unit will turn off the scheduled program.
- 7 When in Program mode, this is the number of minutes the Custom Flow program will run. When running Custom Flow or MAX Flow/Vacuum mode, this field displays the remaining time of your chosen function.

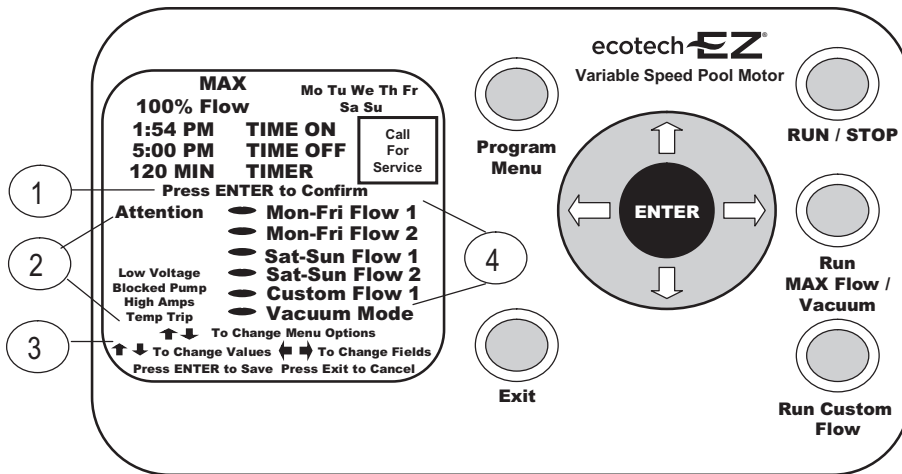

- 1 The "Press ENTER to Confirm" icon illuminates when the unit requests you to confirm your selection.
- 2 The **Attention** section displays important operating information regarding your unit. Detailed information on these items can be found in the Fault section of this manual – Pages 24-25.
 - **Low Voltage** indicates insufficient voltage is getting to the motor.
 - **Blocked pump** indicates there is an obstruction which does not allow the pump to properly operate.
 - **High Amps** is an indication of some type of overloaded condition.
 - **Temp Trip** indicates an overheat condition. If you are unsure how to resolve any of these issues, please call your pool professional.
- 3 Directions for operation. These directions will illuminate based upon your location in the Program menu. "Press Exit to Cancel" is an indicator to press the **Exit** button to leave the program menu or to press the **Exit** button as an Escape key should an error occur while programming.
- 4 These are your program menu selection options.
 - Mon-Fri Flow 1** is the first On, Off and Flow percentage setting for Monday through Friday operation.
 - Mon-Fri Flow 2** is a second On, Off, and Flow percentage available for Monday-Friday operation.
 - Should you require different setting for weekend operation, **Sat-Sun Flow** settings are also available.
 - Four **Custom Flow** settings are also available should special settings be required for water features, backwash, or party mode operation. **Vacuum Mode** is not programmable.

Programming Overview Flow Chart

Each Menu Option has its own programming procedure. See Pages 13-17.

Unit must be in stop mode to access programming. If RUN/STOP button is lit press RUN/STOP to turn off light and put in stop mode.

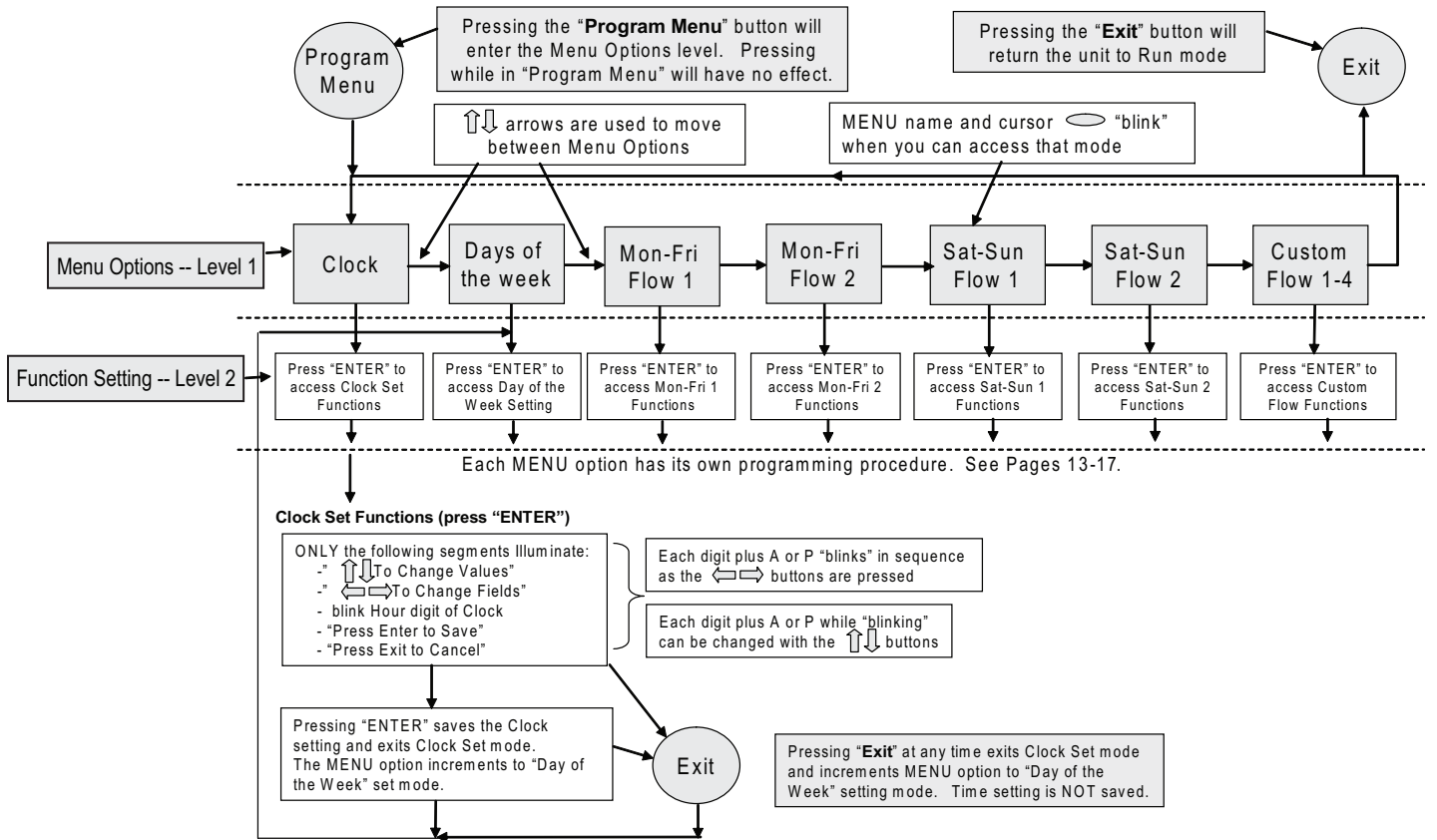

How to Program Your ECOTECH EZ® Motor/Control

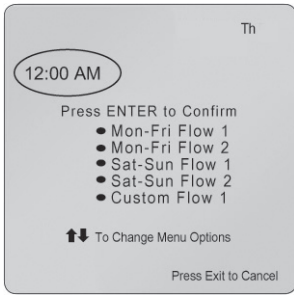
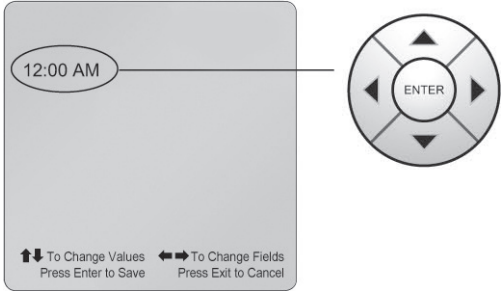
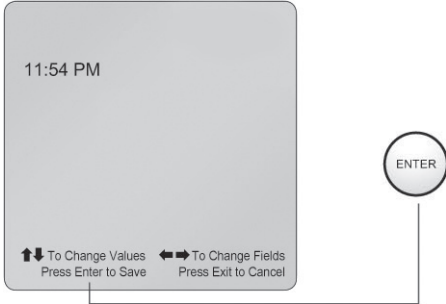
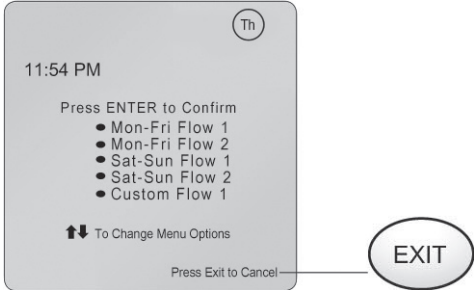
| A) Setting the Clock | |
|--|--|
| <p>1. See page 12 for how to enter clock setting.</p> |  |
| <p>2. The hour digit(s) will be flashing. Use the (up arrow), (down arrow), (left arrow), (right arrow) to set the time and am/pm.</p> |  |
| <p>3. After you have set the correct time, press ENTER to save the time and return to the Menu Options mode. The Days of the Week will be flashing. If you want to change or set the day of the week, press the ENTER button and refer to Section B. If the correct day is already set, proceed to step 4 below.</p> |  |
| <p>4. Press Exit if finished programming, or press Enter to continue.</p> |  |
| <p>5. If finished programming, push RUN/STOP button to run program. (Note: RUN/STOP button should be lit)</p> | |

Please note: In the PROGRAM menu, if no button is pressed within 30 seconds, the unit will EXIT and return to the RUN mode.

B) Day of Week Programming

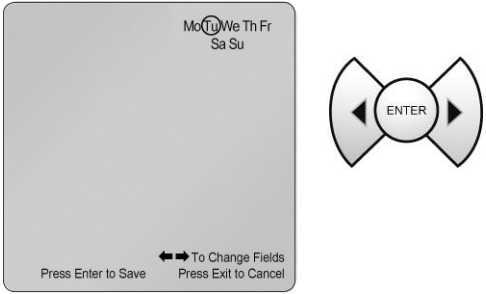
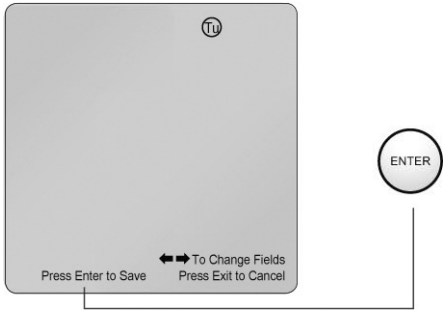
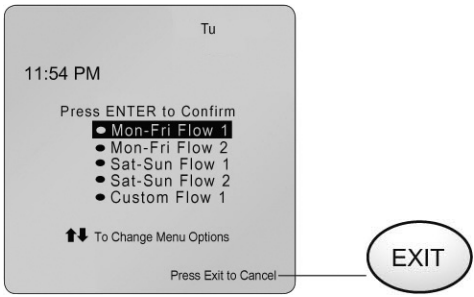
| | |
|--|---|
| <p>1. Use the (right arrow) and (left arrow) to move through the days of the week.</p> |  |
| <p>2. To save the day you have chosen, press Enter. You are now back to the Menu Options mode and the Mon-Fri Flow 1 icon will be flashing. If you would like to change or set the Mon-Fri Flow 1 program, press ENTER and refer to Section C. If not, proceed to # 3 below.</p> |  |
| <p>3. Press Exit if finished programming, or press Enter to continue.</p> |  |
| <p>4. If finished programming, push RUN/STOP button to run program. (Note: RUN/STOP button should be lit)</p> | |

C) Mon-Fri Flow 1 Programming (Flow 2 Programming is similar)

NOTE: Flow 1 settings take precedence over Flow 2 settings if Start Times are the same.)

Setting on and off time the same is not recommended. For 24 hour operation, see page 21.

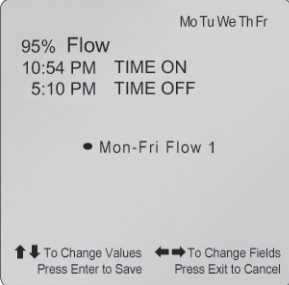
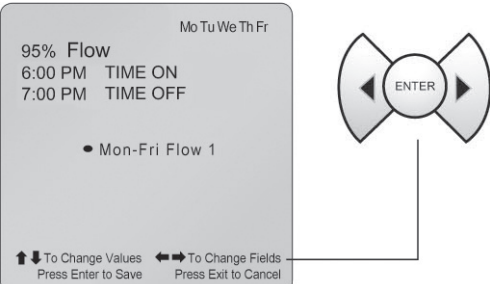
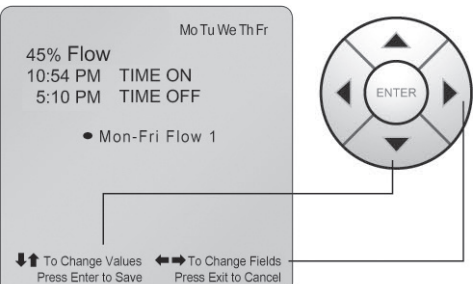
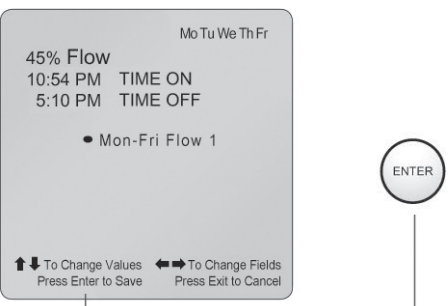
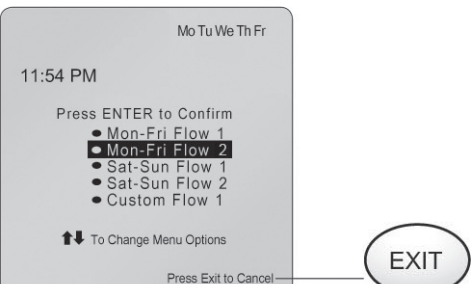
| | |
|---|--|
| <p>1. Use (up arrow) and (down arrow) to set the desired % flow setting.</p> |  |
| <p>2. Press the (right arrow). Use the instructions for Setting the Clock to set the Time On and Time Off on this screen.</p> |  |
| <p>3. Use the (left arrow) and (right arrow) to move through the time and flow setting process. Use (up arrow) and (down arrow) to increase or decrease Time and Flow.</p> |  |
| <p>4. Press Enter when you are finished setting the desired Flow 1 rate and times of operation. Repeat steps 1-3 to set a 2nd flow rate and time for Mon-Fri operation. If not, proceed to # 5 below.</p> |  |
| <p>5. Press Exit if finished programming or press Enter to continue.</p> |  |
| <p>6. If finished programming, push RUN/STOP button to run program. (Note: RUN/STOP button should be lit)</p> | |

D) Sat-Sun Flow 1 Programming (Flow 2 Programming is similar)

NOTE: Flow 1 settings take precedence over Flow 2 settings if Start Times are the same.

Setting on and off time the same is not recommended. For 24 hour operation, see page 21.

| | |
|---|--|
| <p>1. Use (up arrow) and (down arrow) to set the desired flow %.</p> | |
| <p>2. Press the (right arrow). Use the instructions for Setting the Clock to set the Time On and Time Off on this screen.</p> | |
| <p>3. Use the (left arrow) and (right arrow) to move through the time and flow setting process. Use (up arrow) and (down arrow) to increase or decrease Time and Flow.</p> | |
| <p>4. Press Enter when you are finished setting the desired Flow 1 rate and times of operation. Repeat steps 1-3 to set a 2nd flow rate and time for Sat-Sun operation. If not, proceed to # 5 below.</p> | |
| <p>5. Press Exit if finished programming or press Enter to continue.</p> | |
| <p>6. If finished programming, push RUN/STOP button to run program. (Note: RUN/STOP button should be lit)</p> | |

NOTE: In the PROGRAM menu, if no button is pressed within 30 seconds, the unit will EXIT but will not return to RUN mode.

E) Custom Flow Programming

(NOTE: There can be up to 4 separate Custom Flow settings. All will be programmed as follows)

1. Use (up arrow) and (down arrow) to move through the four flow settings.

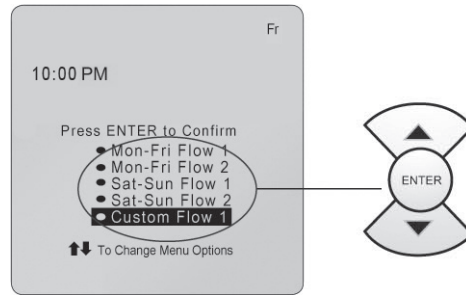

2. Use the (left arrow) and (right arrow) to move through the time and flow setting process. Use (up arrow) and (down arrow) to increase or decrease Time and Flow.

Custom Flow 1, 2, 3, 4

% Flow Range: 0 – 100%

Time Range: 10-249 minutes

(Holding down the “Up” or “Down” arrows while setting the timer, will change the value rapidly)

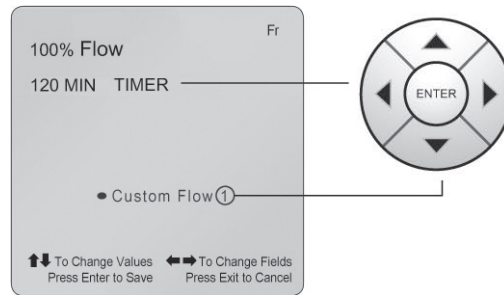

3. After you have set the Custom Flows 1 through 4, press Enter to save. You are now returned to the Clock Set Programming if needed.

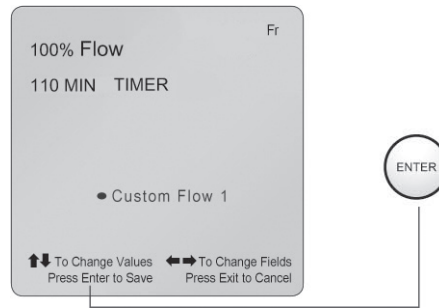

4. Press Enter when you are finished setting the desired Custom Flow, rate and times of operation. Repeat steps 1-3 to set Custom Flow rates 2-4.

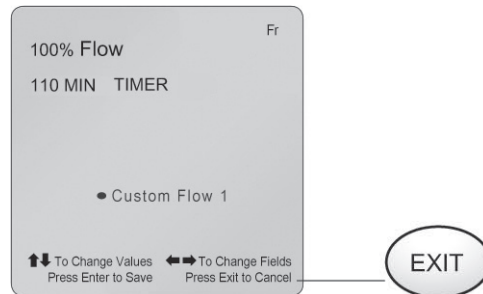

5. Press Exit if finished programming or press Enter to continue.

6. If finished programming, push RUN/STOP button to run program.

(Note: RUN/STOP button should be lit)

Programming for Pump Priming (change from default setting)

Unit must be in Stop mode to access programming. If RUN/STOP button is lit press RUN/STOP to turn off light and put in Stop mode.

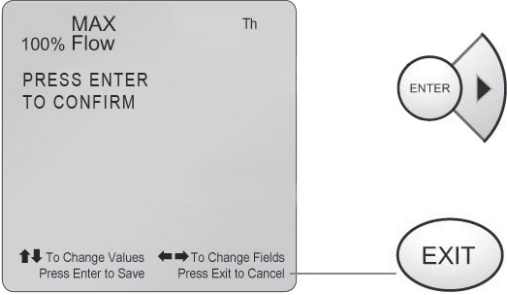
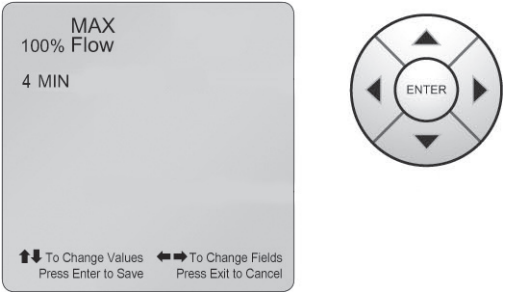
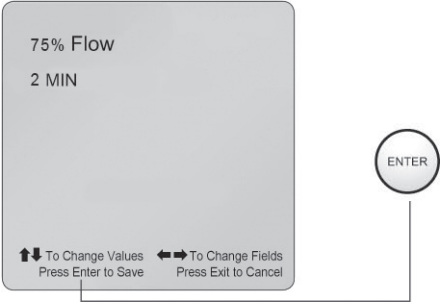
| | |
|---|---|
| <p>1. Press the right arrow and EXIT button at the same time for 2 seconds (Note: the unit must not be running “STOP” condition, before setting program).</p> |  |
| <p>2. Use the (left arrow) and (right arrow) to move through the time and flow setting process. Use (up arrow) and (down arrow) to increase or decrease Time and Flow.</p> <p>% Flow Range: 30 – 100%</p> <p>Time Range: 0-10 minutes</p> <p>(Note: Set time to 0 to disable priming)</p> |  |
| <p>3. After you have set the desired Pump Priming program, press ENTER to save. The example shown on the display is for a 2 minute priming time/duration at 75% Flow.</p> |  |
| <p>4. If finished programming, push RUN/STOP button to run program.</p> <p>(Note: RUN/STOP button should be lit)</p> | |

ECOTECH EZ® Motor/Control Operation Continued:

This section describes additional operations and features.

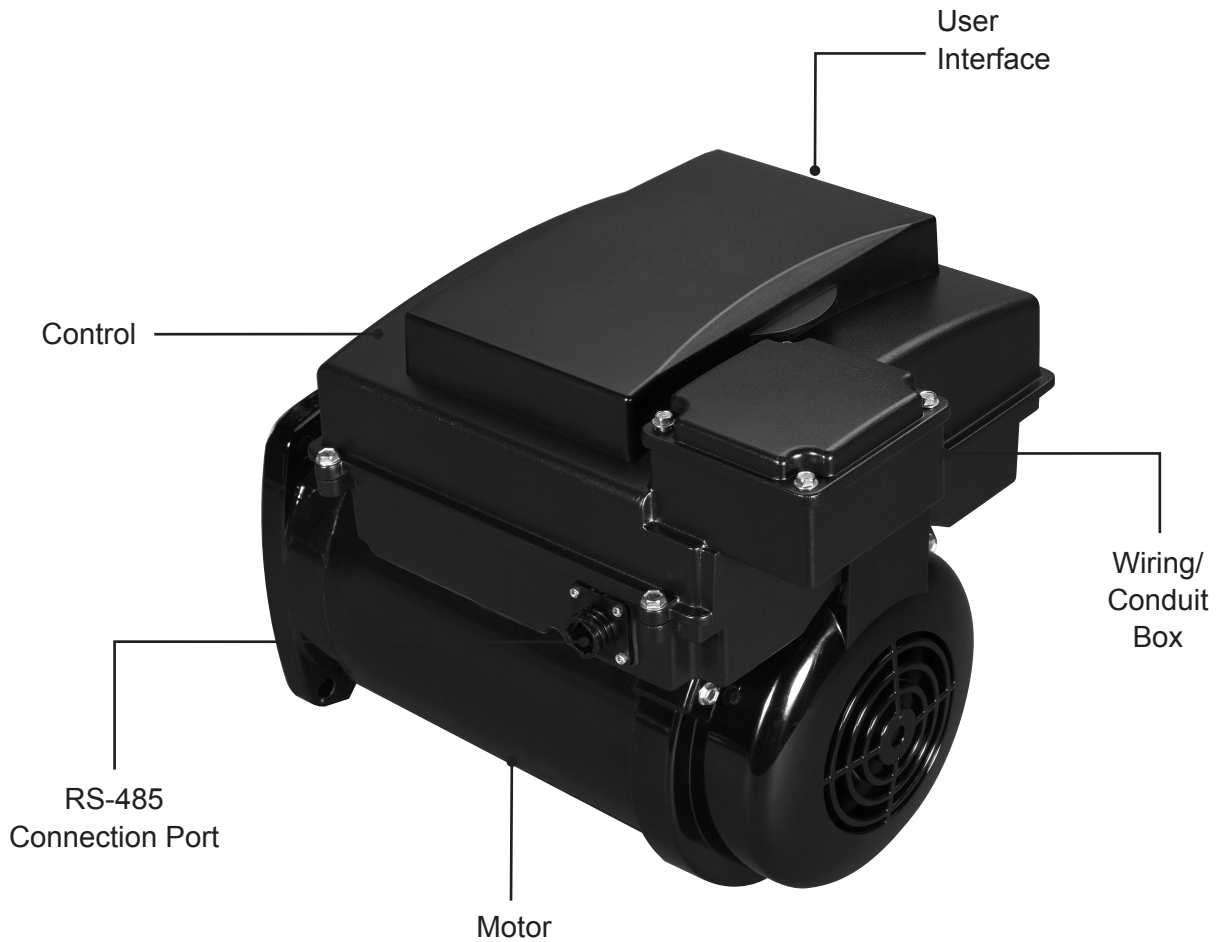

56J Mounting

NOTE: SHAFT EXTENSION
#303 STAINLESS STEEL

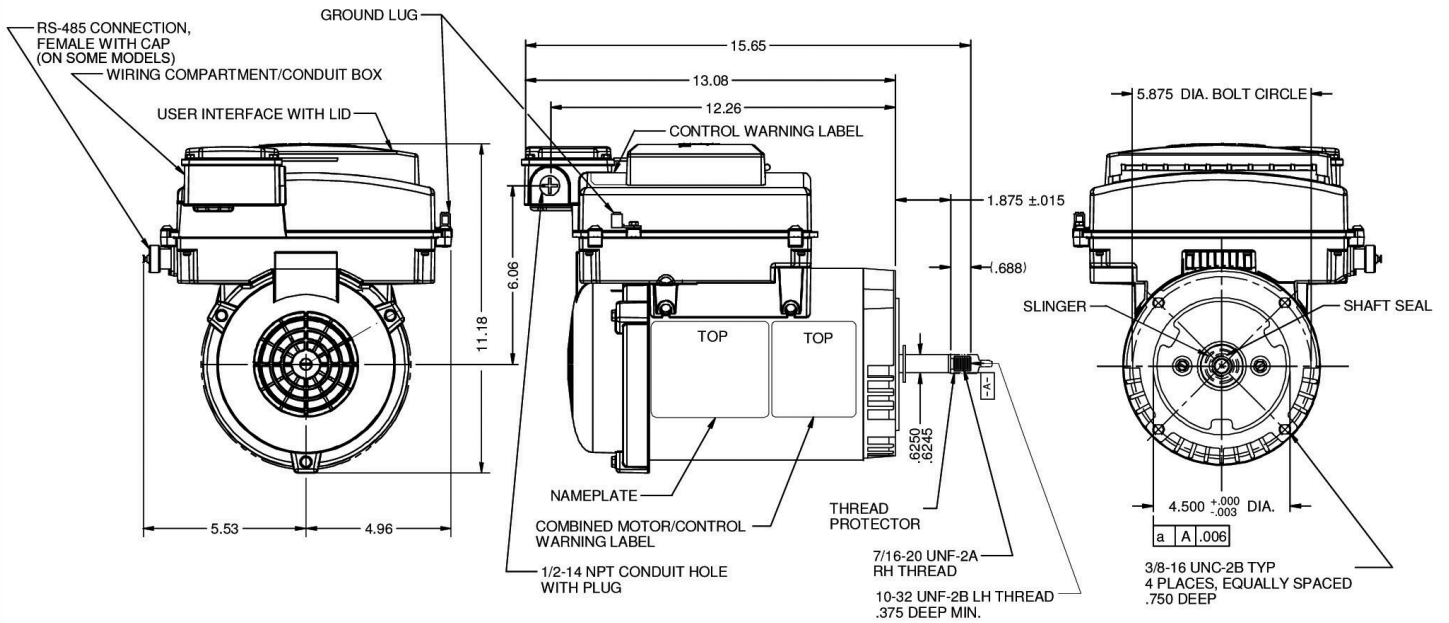

Square Flange Mounting

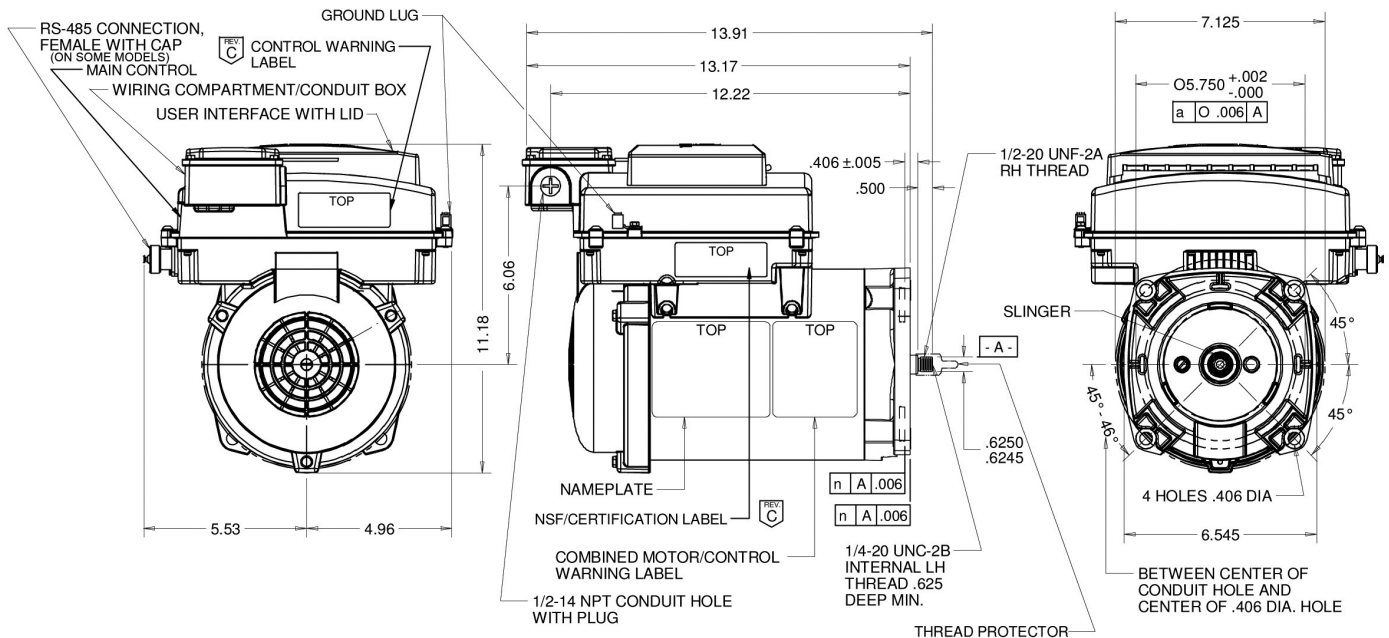

Starting the Pump and Motor/Control

If the **RUN/STOP** button is illuminated, the motor is in the RUN mode. If the Clock is set and the time of day and day of week corresponds to a scheduled Program On time, the motor will automatically ramp up to speed within a few seconds. Be aware the unit will start in Prime mode running at full speed for four minutes. After the priming period has expired, the pump will operate at the flow percent demanded by the operating mode which caused the pump to start. When the unit is in Prime mode, the word "MAX" will flash above the percentage flow indicator.

Pressing the **Run Custom Flow** button followed by the **ENTER** button will start the pump in the current Custom Flow 1 setting. To start the pump in the Custom Flow # 2 setting, press **Run Custom Flow** twice before pressing **ENTER**; Press the **Run Custom Flow** button three (3) times then press **ENTER** to Run Custom Flow 3 and Press the **Run Custom Flow** button Four (4) times then press the **ENTER** button to start the pump in the Run Custom Flow 4 mode.

Stopping the Pump and Motor/Control

Press the **RUN/STOP** button to stop the pump. The button will no longer be illuminated.

Running the ECOTECH EZ® Motor/Control per the Program Schedule

The **RUN/STOP** button must be illuminated. The motor/control will turn on and off automatically at the programmed start and stop times and it will operate at the programmed flow rates. The LCD screen will display the current operating flow rate in percentage of maximum format, the current time of day, the current day of the week, and the current or next Program Schedule that will run. The Program Schedule may be overridden by pressing the **Run Custom Flow** button or by pressing the **Run MAX Flow/Vacuum** button.

The user interface includes two programmable % Flow time periods for weekdays, Monday through Friday, and two programmable % Flow steps for weekends, Saturday and Sunday. These are the times at which the motor/control will turn on and operate at the programmed percentage flow until the time scheduled for Time Off.

The Default or preprogrammed settings are as follows:

Mon – Fri Flow 1: 7:30AM Time On and 4:00PM Time Off
running at 50% Flow

Mon – Fri Flow 2: 4:00PM Time On and 6:00PM Time Off
running at 70% Flow

Sat – Sun Flow 1: 7:30AM Time On and 4:00PM Time Off
running at 50% Flow

Sat – Sun Flow 2: 4:00PM Time On and 6:00PM Time Off
running at 70% Flow

Custom Flow 1 80% 120 min

Custom Flow 2 55% 240 min

Custom Flow 3 0% 10 min

Custom Flow 4 0% 10 min

You can also schedule the unit with overlapping program schedules. An example:

Mon – Fri Flow 1: 7:30AM Time On and 8:00PM Time Off
running at 40% Flow

Mon – Fri Flow 2: 4:00PM Time On and 6:00PM Time Off
running at 70% Flow

Sat – Sun Flow 1: 7:30AM Time On and 8:00PM Time Off
running at 45% Flow

Sat – Sun Flow 2: 4:00PM Time On and 6:00PM Time Off
running at 75% Flow

During the weekdays, the pump will run at 40% flow from 7:30AM until 4:00PM then run at 70% flow from 4:00PM to 6:00PM. At 6:00PM, the pump will revert back to the 40% Flow rate until 8:00PM. The same logic also applies to the above weekend program schedule. This feature could be used to save energy dollars by running the pump longer hours at slower flow rates while allowing for higher flow operation during cleaning or high traffic periods.

For 24 Hour Operation

Setting the same On and Off times may cause the unit not to run. An example:

Mon – Fri Flow 1: 6:00 AM Time On and 6:00 AM Time Off
running at XX%.

The unit will turn on and off at the same time and will not run.

The recommended schedule for 24 hour operation is by using both Mon – Fri or Sat – Sun Flows. An example:

Mon – Fri Flow 1: 7:00AM Time On and 7:00PM Time Off
running at 40% Flow

Mon – Fri Flow 2: 7:00PM Time On and 7:00AM Time Off
running at 40% Flow

Sat – Sun Flow 1: 7:00AM Time On and 7:00PM Time Off
running at 40% Flow

Sat – Sun Flow 2: 7:00PM Time On and 7:00AM Time Off
running at 40% Flow

Priming the Pump

▲ NOTICE Please follow all instructions from the pump manufacturer's product manual regarding the pump priming operation.

For the factory default setting, every time the pump starts from an Off condition (0% Flow), to ensure the pump is properly primed, the pump will ramp to full speed (100% Flow) for four minutes. When this occurs, the MAX icon will be flashing above the percentage flow indicator. After the priming time has expired, the pump will operate at the flow percent that is shown in the display. If it is less than 100%, the MAX icon will turn off.

The factory default setting can be changed to flows from 30% to 100% (in 5% increments), and time/duration from 0 to 10 minutes (in 1 minute increments). For NO PRIME, 0 minutes should be selected. During priming, the "% Flow" indicator flashes. See page 18 Section F "Programming for Pump Priming" for detailed instruction.

Run Max Flow / Vacuum Mode

To enter this mode, press the Run Max Flow / Vacuum button then press the Enter button. This mode provides an operation of 100% Max Flow for a duration of 30 minutes. These settings CANNOT be adjusted. While running in this mode, the Timer on the user interface will show the time remaining in the function and the percentage flow will show 100% Max Flow.

If additional time is needed to clean and vacuum the pool, or you would like to extend the time in this mode, pressing the Run Max Flow / Vacuum button again before the timer reaches zero minutes will reset the timer to 30 minutes.

After the completion of this mode, the unit will resume running per the program schedule.

The Run Max Flow / Vacuum mode may be stopped at any time by pressing the **Exit** button.

Manual Speed (Flow) Adjustment

While the pump is operating in any of the programmed flow modes, (Mon-Fri, Sat-Sun, or Custom Flows), the flow rate (speed) can be adjusted by pressing of the "Up" or "Down" arrows. Each press of the "Up" arrow will increase the % Flow by 5% increments until a maximum of 100% is reached. Additional pushes of the key will have no further effect. Each press of the "Down" arrow will decrease the % Flow by 5 % increments until a minimum of 30% is reached. Additional pushes of the key will have no further effect. When the % Flow is changed manually with the

"Up" and "Down" arrow keys the setting is not stored, but will be maintained until a change in flow is called for by the program, or the operating mode is cancelled.

Run Custom Flow Mode

This function's purpose is to allow for regular or special objectives to be accomplished with a minimal amount of effort for the user. For example, the default value for Custom Flow 1 is as follows: programmed. For instructions on setting additional Custom Flow settings, see page 17.

To Run the Custom Flow operation:

Pressing the Run Custom Flow button followed by the ENTER button will start the pump in the current Custom ENTER.

Pressing the Up or Down arrow keys before pressing ENTER will cycle through the 4 Custom Flow settings. When running, the Timer on the user interface will show the time remaining in the program and the percentage flow will show the programmed percentage of Flow. The timer will count down the minutes remaining in your function.

The Run Custom Flow mode can be stopped at any time by pressing the Exit button.

Freeze Protection Feature

▲ NOTICE This feature is for protection of the pump so water does not freeze inside the pump.

How it works: The user interface control will monitor the ambient temperature around the motor/control when the motor/control is turned off. If the ambient temperature falls below 40°F, the user interface will run the motor/control at minimum speed (30% Flow) for 30 minutes followed by 30 minutes of zero flow time. The freeze protection cycle will not override the time when the Program Schedule would normally operate the pump.

▲ NOTICE This feature is not for winterizing or closing a pool in a colder climate.

Winterize

For colder climates where the pool is closed for the winter season, the electrical power should be shut off to the motor at the circuit breaker.

▲ NOTICE Follow all pump manufacturer instructions regarding Winterizing the pump and system.

Reset to Factory Defaults

Resetting the factory defaults will return the programmable settings to the factory defaults. Activating the reset to factory default option is done by pressing the Left arrow button, the Exit button, and the Run/Stop button. When this button combination is pressed for more than two seconds the reset to factory defaults mode will activate. The following will be reset to the factory default settings:

The Program Schedule:

Mon – Fri Flow 1: 7:30AM Time On and 4:00PM Time Off running at 50% Flow

Mon – Fri Flow 2: 4:00PM Time On and 6:00PM Time Off running at 70% Flow

Sat –Sun Flow 1: 7:30AM Time On and 4:00PM Time Off running at 50% Flow

Sat – Sun Flow 2: 4:00PM Time On and 6:00PM Time Off running at 70% Flow

The Custom Flow 1 Setting:

80% Flow for a duration of 120 minutes

The Custom Flow 2 Setting:

55% Flow for a duration of 240 minutes

The Custom Flow 3 Setting:

0% Flow for a duration of 10 minutes

The Custom Flow 4 Setting:

0% Flow for a duration of 10 minutes

Backup Power Supply

In the event the power would go out and not supply your ECOTECH EZ[®] motor/control, the user interface will keep the current day of the week settings and the time of day settings for 12-16 hours without power to the motor. Your Program Schedule and your Custom Flow settings will remain intact in the event the power is out longer than 12-16 hours. Should the power outage extend longer than the backup power supply, reset your clock and day of the week to resume operations.

▲ NOTICE These instructions can be found on page 13 of this guide.

Locking the Keypad

To prevent inadvertent or unauthorized changing of the program parameters, the keypad can be locked. To lock the keypad, use the following procedure:

1. Press the ENTER and the Exit buttons simultaneously and hold for 2 seconds. After 2 seconds the “Press ENTER to Confirm” icon in the display will start blinking.
2. Press Enter.
The keypad is now locked, and the letters “LOC” will be shown in the display for 5 seconds.

After 5 seconds, the letters “LOC” will go off, and the display will revert back to showing the Time, Day of Week, % Flow rate, operating mode the unit was running (i.e. Mon-Fri Flow 1, Custom Flow, or Vacuum). (If keypad lockout is activated while in Custom Flow or Vacuum mode, those modes will continue to operate and time out per the programmed times. When those operating modes are complete, the unit will either revert back to the appropriate Mon-Fri or Sat-Sun programmed modes or the motor will stop depending on which mode the unit was in prior to entering the Custom Flow or Vacuum mode)

Pressing of any button on the keypad (other than the RUN/STOP button), while the keypad is locked will cause the display to completely blank except for the letters “LOC” which will be displayed for 5 seconds after the button is pressed. After 5 seconds, the display will revert back to what was being displayed prior to the button press.

Pressing of the Run/Stop button while the keypad is locked, will either stop the motor if it was running and turn off the RUN/STOP LED, or start the motor in program mode if it was stopped and turn on the RUN/STOP LED.

Note: If a power outage occurs while the keypad is locked, when power is restored the keypad will remain locked.

To exit the keypad lockout mode:

1. Press the ENTER and the Exit buttons simultaneously and hold for 2 seconds. For the first 2 seconds, the display will show the letters “LOC”. After 2 seconds, “LOC” will go out and the “Press ENTER to Confirm” icon will start blinking.

2. Press Enter.

The keypad is now unlocked and all of the buttons will function normally. The display will revert back to showing the Time, Day of Week, % Flow rate, the program mode the unit is running. (If the ENTER button is not pressed within 5 seconds, the keypad will stay locked, the “Press ENTER to Confirm” icon will go out, and the display will revert back to showing the Time, Day of Week, % Flow rate, and the program mode the unit is running).

Operating the ECOTECH EZ® Motor/Control via an External Controller (on some models)

There is an RS-485 port on the side of the motor/control available for connection to an external controller. If an external controller is connected to this product, the user interface is no longer in control of the unit.

The external controller takes precedence.

If an external controller is utilized, make sure the following conditions are met:

- 10 meter maximum line length from the controller to the motor
- This line must be an isolated, non-grounded connection
- Contact US Motors/Nidec Motor Company for the proper communication protocol
- Contact information can be found on page 2 of this manual

Operating the ECOTECH EZ® Variable Speed Pool Motor/Control with other Equipment Pad Items

Heaters:

If your pool heater has a time clock function, it is very important to ensure the pool filtration pump is running whenever the pool heater is running. The pool heater should not run during times when the filtration pump is off. The pool heater program timer setting should be set to start and stop during the program on and off times programmed on your ECOTECH EZ® variable speed pool motor/control. Be aware of the backup power supply feature on the ECOTECH EZ® motor/control as other time clocks may lose the correct time in the event of a power outage.

▲ NOTICE It is good practice to check and/or reset the current time of day and day of week settings on your equipment pad time clocks in the event of a power outage or during spring or fall time changes.

Pool Cleaners with Booster Pumps:

It is recommended to start your pool sweep one hour or more after your filtration pump has started and stopping the pool sweep one hour or more before your filtration pump shuts off. If your pool cleaner operates on a time clock, it is very important to set your pool sweep on and off times per the above recommendation. Be aware of the backup power supply feature on the ECOTECH EZ® motor/control as other time clocks may lose the correct time in the event of a power outage. It is a good practice to check and perhaps reset the current time of day and day of week settings on your equipment pad time clocks in the event of a power outage or in the event of a spring or fall time change.

Refer to the manufacturer’s product manual for your pool cleaner for proper cleaning time durations.

Pool Cleaners without Booster Pumps:

After your ECOTECH EZ® Motor/Control is running and your pump is fully primed, refer to the pool sweep manufacturer’s startup procedures then follow the procedures for Run Max Flow / Vacuum mode found on page 16 of this manual.

If an item has a timer regulating its operation, it can be very important that the equipment pad item runs only when the ECOTECH EZ® Motor/Control is running. Check the item’s product manual to properly determine if the item should run only when the filtration pump is running. If this is the case, follow these instructions when synchronizing the timer operations of your various equipment pad items.

▲ NOTICE It is a good practice to check and reset the current time of day and day of week settings on your equipment pad time clocks in the event of a power outage or in the event of a spring or fall time change.

▲ NOTICE Please follow the operating instructions of these equipment pad items.

Fault Conditions

The user interface advises when certain fault conditions occur. These fault conditions may be resolved at the equipment pad.

Low Voltage Trip

The voltage to the motor/control conduit box terminals must be 230 volts AC (Alternating Current), +/- 10% or 207-253 volts AC, 60 Hertz. A sustained input voltage significantly below 207 volts AC will cause a Low Voltage Trip to occur. This trip will occur if 115 volts AC is applied to the conduit box terminals instead of the required 230 volts AC. When this Low Voltage Trip occurs, the Call for Service icon, the Attention icon and the Low Voltage icon will illuminate on the LCD screen. The pump will also shut down and automatically restart when operating conditions are within specifications. The pump will begin ramping up to speed slowly until reaching the percentage flow or speed for which the motor/control was running prior to the fault occurring. When this fault occurs, this could indicate a problem with the input line voltage or wiring to the unit.

▲ NOTICE If this fault continues to occur even after verifying that the input line voltage is between 207-253 volts AC, then call your pool professional or a qualified electrician for service.

Blocked Pump Trip

The Blocked Pump fault is an indication of a mechanical obstruction causing the motor shaft not to turn. When this occurs, the Blocked Pump icon and the Attention icon will illuminate on the LCD screen. The pump will shut down. This is a self-resettable fault, meaning the motor/control will attempt to restart by ramping to the percentage flow for which the motor/control was running prior to the fault. This reset will occur up to five times after which the user must press the Exit button to recheck the system to determine if the Blocked Pump condition still exists. If not, the pump will begin ramping up to speed slowly until reaching the percentage flow or speed for which the motor/control was running prior to the fault occurring. If the condition still exists, the fault will occur again.

▲ NOTICE If the Exit button is pressed a second time and the Blocked Pump condition still exists, the Call for Service icon will illuminate.

High Amps Trip

The High Amps Trip is an indication of a possible motor/control overload. When this occurs, the High

Amps icon and the Attention icon will illuminate on the LCD screen. The pump will shut down. This is not a self-resettable fault and the user must press the Exit button to recheck the system to determine if the High Amps condition still exists. If not, the pump will begin ramping up to speed slowly until reaching the percentage flow or speed for which the motor/control was running prior to the fault occurring. If the condition still exists, the fault will occur again.

▲ NOTICE If the Exit button is pressed a second time and the High Amps condition still exists, the Call for Service icon will illuminate.

Temp Trip Fault

The Temp Trip is an indication of an excessive operating temperature that could damage the motor control. When this occurs, the Temp Trip and Attention icon will illuminate and the pump will shut down. After 5 minutes, the motor will restart automatically, and if the temperature has dropped to a safe value, will begin ramping up to speed slowly until reaching the percentage flow or speed the motor/control was running prior to the fault occurring. During restart, if the operating temperature is still excessive, the unit will shut down again for another 5 minutes. When this fault occurs, this could indicate inadequate ventilation around the product. Make sure there is proper ventilation around the product by removing any leaves or other items which may be restricting the air flow around the motor and control.

▲ NOTICE If it trip persists, call your pool professional or a qualified electrician for service.

All Internal Faults

Internal faults are failure conditions that do not have an icon in the LCD display. These faults usually result in control failure, but may be cleared by cycling the main power. If the Attention and the Call for Service icons illuminate and the pump has stopped, turn off the power for 10 minutes at the main circuit breaker then turn the power back on to reset the system. If this step does not clear the fault, contact your pool professional for service.

General Troubleshooting

Also refer to Fault Conditions section on page 24. This chart recommends common answers to electric motor issues. Refer to your pump manual for hydraulic guidance. When repetitive issues occur, Nidec Motor Corporation recommends contacting your local pool and spa professional for technical assistance.

| Symptom | Possible Causes | Corrective Action |
|--|---------------------------------------|--|
| Motor/Control Fails to Start | Blown Fuse or Tripped Circuit Breaker | Turn off motor/control. Replace fuses with time delay type or reset the breaker. |
| | Incorrect Voltage to Motor/Control | Verify motor/control voltage to the terminals match the nameplate voltage requirements. 207-253 Volts (60 Hertz) is the allowable voltage range for this product. Is there a timer, a controller, or a line switch? Are they in the ON position? |
| | Improper terminal connections | Turn off power. Verify connections are per the nameplate connection diagram. |
| | Blocked Pump or Shaft | Turn off power. Follow pump manufacturer's instructions for dislodging foreign matter inside the pump. |
| Motor/Control does not come up to full speed | Application issue | Call your pool service professional. The motor/control could be overloaded. |
| | Low Voltage | Verify motor/control voltage to the terminals matches the nameplate voltage requirements. |
| Motor/Control stalls during operation | Overloaded Motor/Control | Reduce the load or % Pump Flow. |
| | Low Voltage | Verify motor/control voltage to the conduit box connection terminals matches the nameplate voltage requirements. |
| Motor vibrates or is excessively noisy | Motor and Pump misalignment | Consult your pump manual for proper alignment instructions or call your pool service professional. Before taking any corrective actions, ensure the power is OFF. |
| | High Voltage | Verify motor/control voltage to the terminals matches the nameplate voltage requirements. |

How to Lower Utility Costs with the ECOTECH EZ® Variable Speed Pool Motor/Control

Your electric bill is based on the number of Kilowatt's used in a typical billing cycle. Each Kilowatt is 1,000 watts. To calculate how much energy your current pool motor is using and to calculate your savings potential with the ECOTECH EZ® motor/control, visit www.nidec-motor.com/pool and use our energy calculator. The calculator will show you how many hours to run your pump each day along with the appropriate percentage flows for maximum energy savings. Contact your utility company to determine if there are times during the day when usage is prohibited, then program your ECOTECH EZ® motor/control to either not run or to run at a very low flow rate during these periods.

NOTE: By reducing your speed to 50% Flow, your horsepower requirement is reduced to 1/8th of the 100% or Max Flow Hp. The calculation is as follows: $(50/100 * 50/100 * 50/100) = .125$ or 12.5%. To run the pump at 30% flow: $(30/100 * 30/100 * 30/100) = 0.027$ or 2.7% of the previously used Max Flow Hp. This is a primary advantage of the ECOTECH EZ® Variable Speed Pool Pump and Motor/Control! See our energy calculator to determine your energy savings by reducing the motor/control speed while enabling the proper amount of daily flow to properly filter your pool.

Recommended Maintenance

▲ WARNING Before performing any maintenance, disconnect the power, allow the motor to come to a complete stop and wait five minutes. This will allow the control capacitors to safely discharge any residual voltage.

Periodically inspect the installation. Check for dirt accumulations, unusual noises or vibration, overheating, worn or loose couplings, high motor amps, poor wiring or overheated connections, and for loose mounting bolts or guards.

Remove dirt accumulation, particularly in and around the ventilation openings on the motor by vacuuming. Dirt accumulations can cause motor overheating and a fire hazard.

Do not use any type of solvents! Some solvents may attack the motor insulation, finish or bearing lubricants. Solvents are also highly flammable.

This motor contains ball bearings which are permanently lubricated. No maintenance is required.

LIMITED WARRANTY

Nidec Motor Corporation extends the following LIMITED WARRANTY to the purchaser and to its customers (collectively referred to as the "Purchaser") of the enclosed motor and components: the motor and components are free from defects in materials and workmanship under normal use, service and maintenance FOR A PERIOD OF 18 MONTHS FROM THE DATE OF ORIGINAL PURCHASE FROM NIDEC MOTOR CORPORATION OR THE NIDEC MOTOR CORPORATION DEALER/RETAILER, NOT TO EXCEED 24 MONTHS FROM THE DATE OF MANUFACTURE BY NIDEC MOTOR CORPORATION. THE FOREGOING WARRANTY IS THE ONLY WARRANTY GIVEN AND NO OTHER WARRANTY IS PROVIDED, EXPRESS OR IMPLIED, INCLUDING WITHOUT LIMITATION, MERCHANTABILITY OR FITNESS FOR A PARTICULAR PURPOSE. Certain aspects or disclaimers are not applicable to consumer products, i.e., motors and components acquired by individuals and used for personal, family or household purposes (as distinguished from industrial or other purposes). Some states do not allow limitations on how long an implied warranty lasts, so the above limitation may not apply to you. This warranty gives you specific legal rights, and you may have other rights which vary from state to state.

Certain repairs or services are the responsibility of the Purchaser and the Purchaser is expected to pay for them. This warranty does not extend to any losses or damages due to misuse, accident, abuse, neglect, negligence, unauthorized modification or alteration, use beyond rated capacity, or improper installation, maintenance, application or use, including, without limitation, use in a manner contrary to the accompanying instructions or applicable codes.

If within thirty (30) days after Purchaser's discovery of any warranty defects within the above stated warranty period, Purchaser notifies Nidec Motor Corporation or the dealer from whom the motor was purchased in writing, Nidec Motor Corporation shall, at its option and as Purchaser's sole and exclusive remedy, repair or replace or refund the purchase price for, that portion of the motor and components found by Nidec Motor Corporation to be defective. Failure by Purchaser to give such written notice within the applicable time period shall be deemed an absolute and unconditional waiver of Purchaser's claim for such defects. Purchaser must write or call the dealer from whom the motor was purchased for directions regarding the shipment of the motor, with freight pre- or call the dealer from whom the motor was purchased for directions regarding the shipment of the motor, with freight prepaid by the Purchaser, to an authorized service location for warranty service. If Purchaser is unable to contact the dealer to obtain sufficient instructions regarding the handling of the motor, Purchaser should write Nidec Motor Corporation at the address on the back cover of this manual, giving the model number, the dealer's name, address and number of dealer's invoice; and describing the nature of the alleged defect. Arrangements for warranty service will then be made by Nidec Motor Corporation. If the motor is damaged in transit, Purchaser should file a claim directly with the carrier.

IN NO EVENT, REGARDLESS OF THE FORM OF THE CLAIM OR CAUSE OF ACTION (WHETHER BASED IN CONTRACT, INFRINGEMENT, NEGLIGENCE, STRICT LIABILITY, OTHER TORT OR OTHERWISE), SHALL NIDEC MOTOR CORPORATION'S LIABILITY TO PURCHASER OR ITS CUSTOMER EXCEED THE PRICE PAID BY PURCHASER FOR THE SPECIFIC MOTOR OR OTHER GOODS PROVIDED BY NIDEC MOTOR CORPORATION GIVING RISE TO THE CAUSE OF ACTION. IN NO EVENT SHALL NIDEC MOTOR CORPORATION'S LIABILITY TO PURCHASER OR ITS CUSTOMER EXTEND TO INCLUDE INCIDENTAL CONSEQUENTIAL OR PUNITIVE DAMAGES, WITH RESPECT TO CONSUMER PRODUCTS, SOME STATES DO NOT ALLOW THE EXCLUSION OR LIMITATION OF INCIDENTAL OR CONSEQUENTIAL DAMAGES, SO THE ABOVE LIMITATION OR EXCLUSION MAY NOT APPLY TO YOU.

Pool Motor Product Service Hotline: **1-800-566-1418**
www.nidec-motor.com/pool

Nidec Motor Corporation, 2011; All Rights Reserved.
U.S. MOTORS® is a registered trademark of Nidec Motor Corporation.
Nidec Motor Corporation trademarks followed by the ® symbol are
registered with the U.S. Patent and Trademark Office.

Nidec
NIDEC MOTOR CORPORATION

8050 W. Florissant Avenue | St. Louis, MO 63136
Phone: 888-637-7333 | Fax: 314-553-2087
www.nidec-motor.com | www.usmotors.com